

FIG. 1

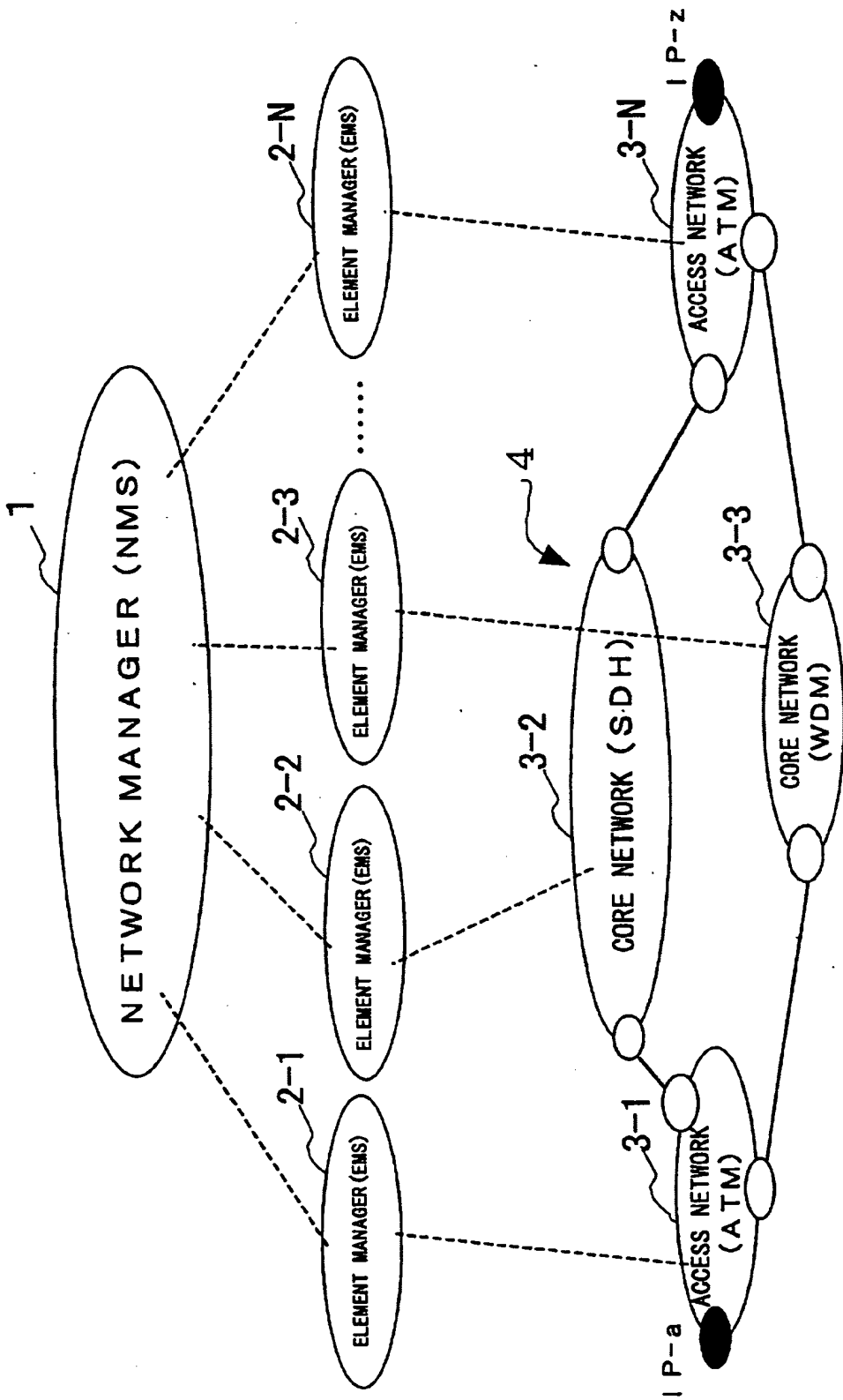
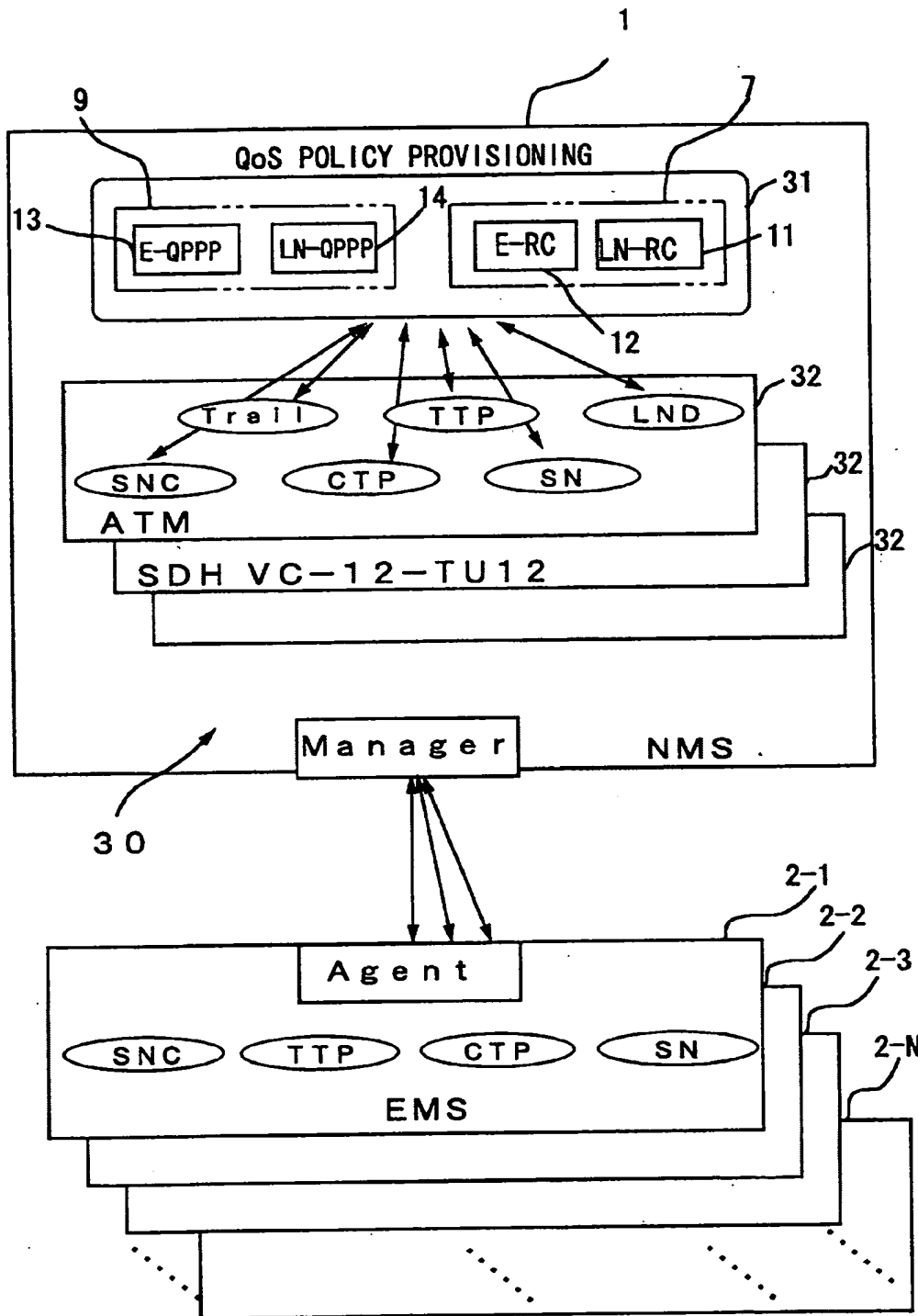

FIG. 2



003260-2370-3100

MANAGEMENT OBJECT  
 [ ] : FUNCTION OBJECT  
 ( ) : INFORMATION OBJECT

FIG. 3

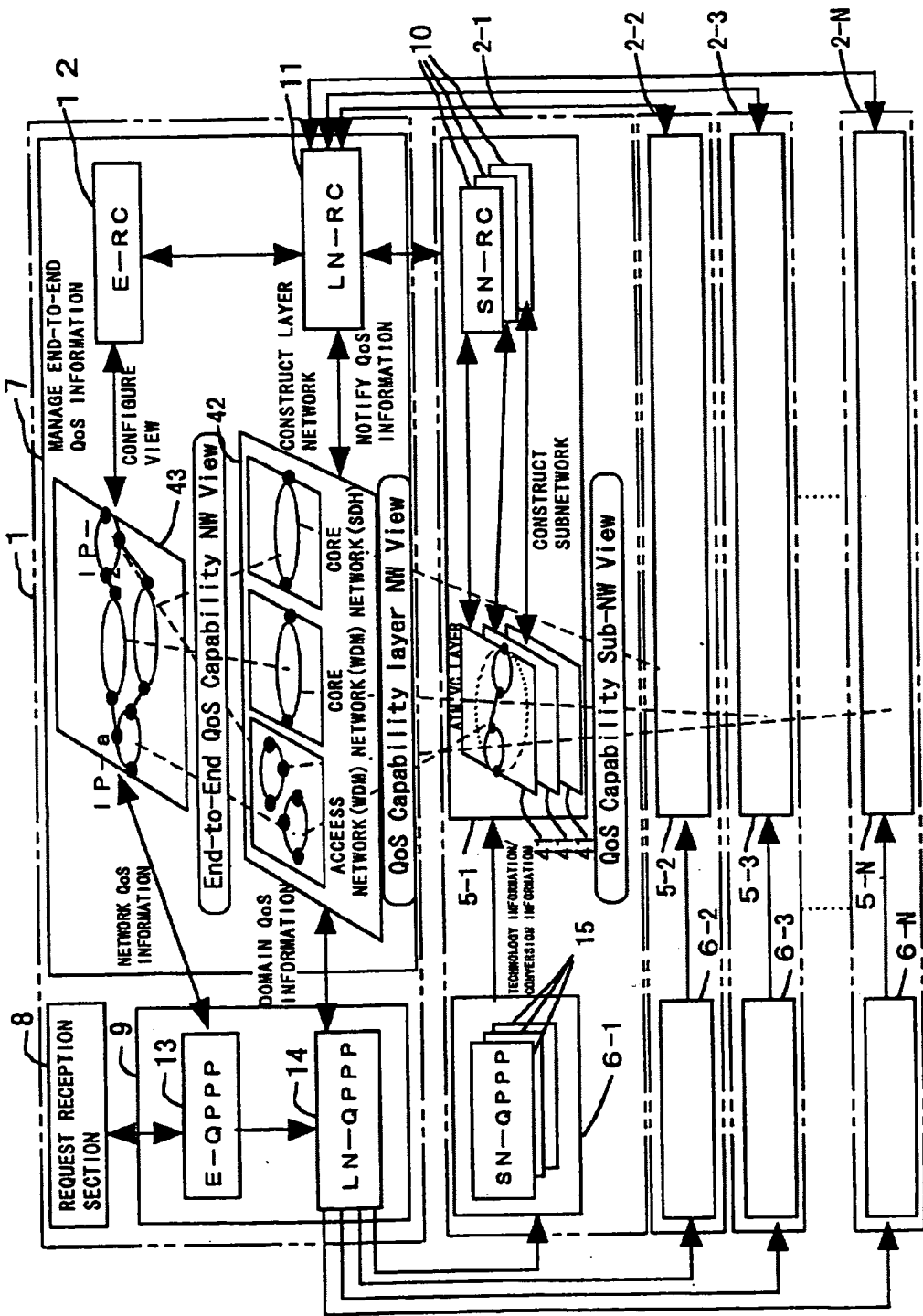

FIG. 4

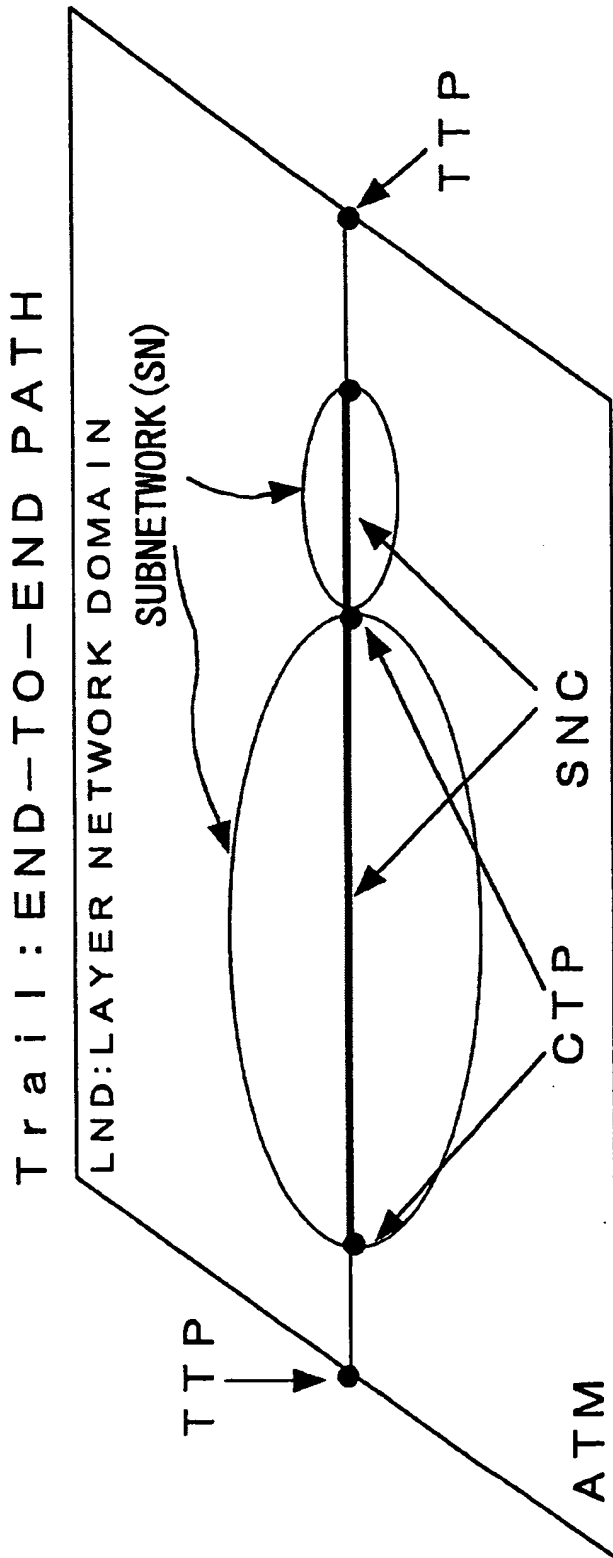

FIG. 5

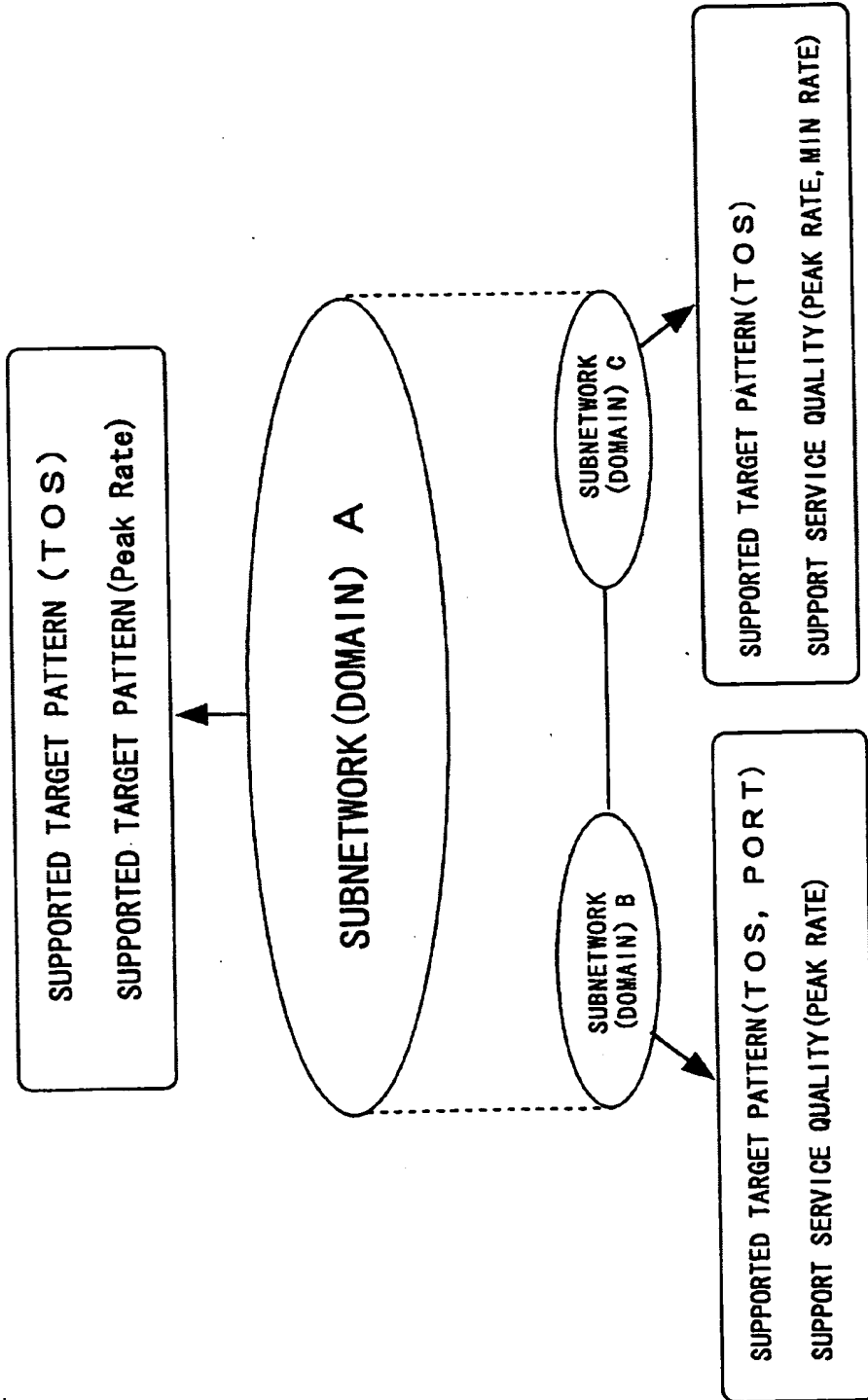

FIG. 6

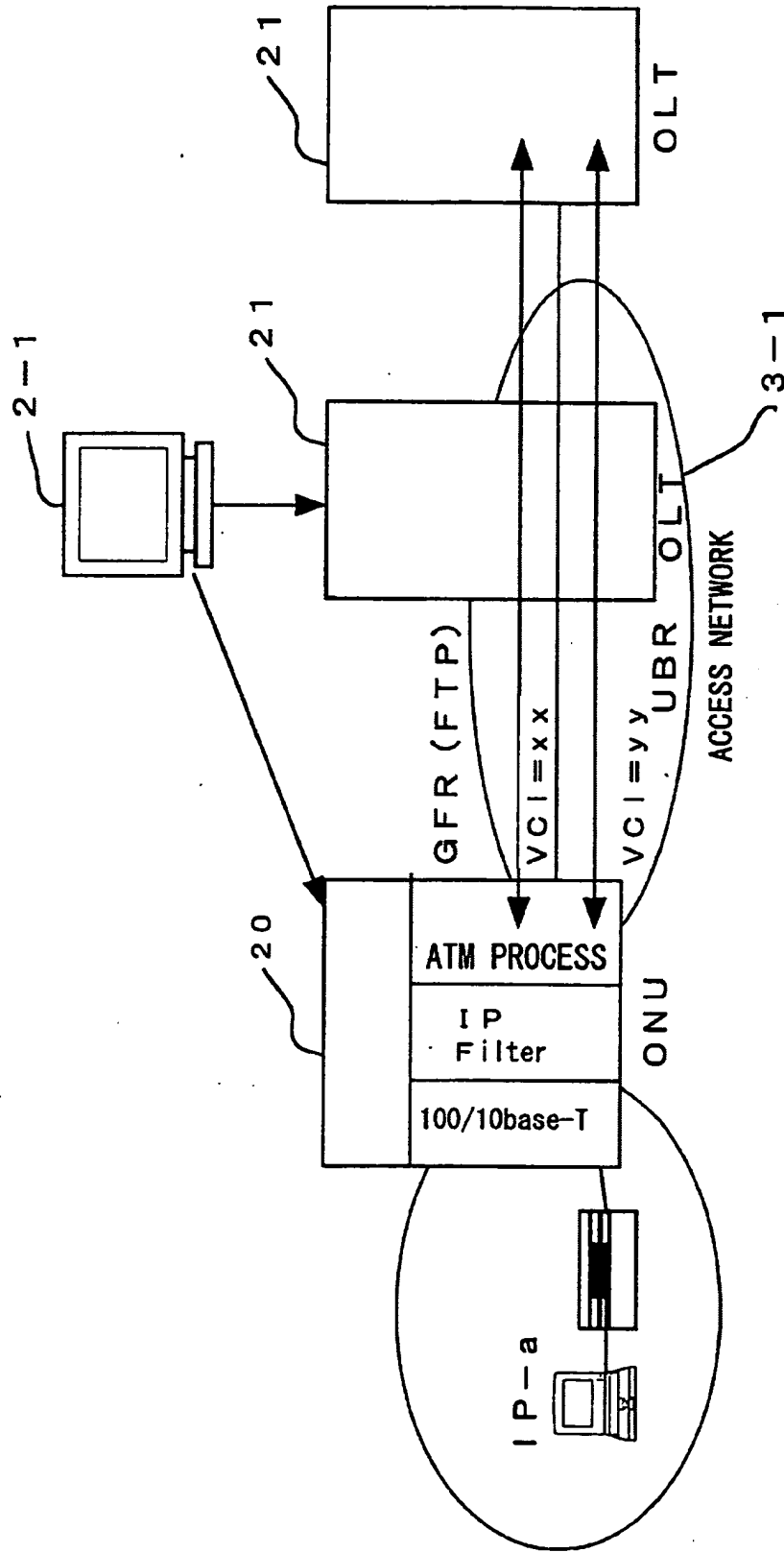
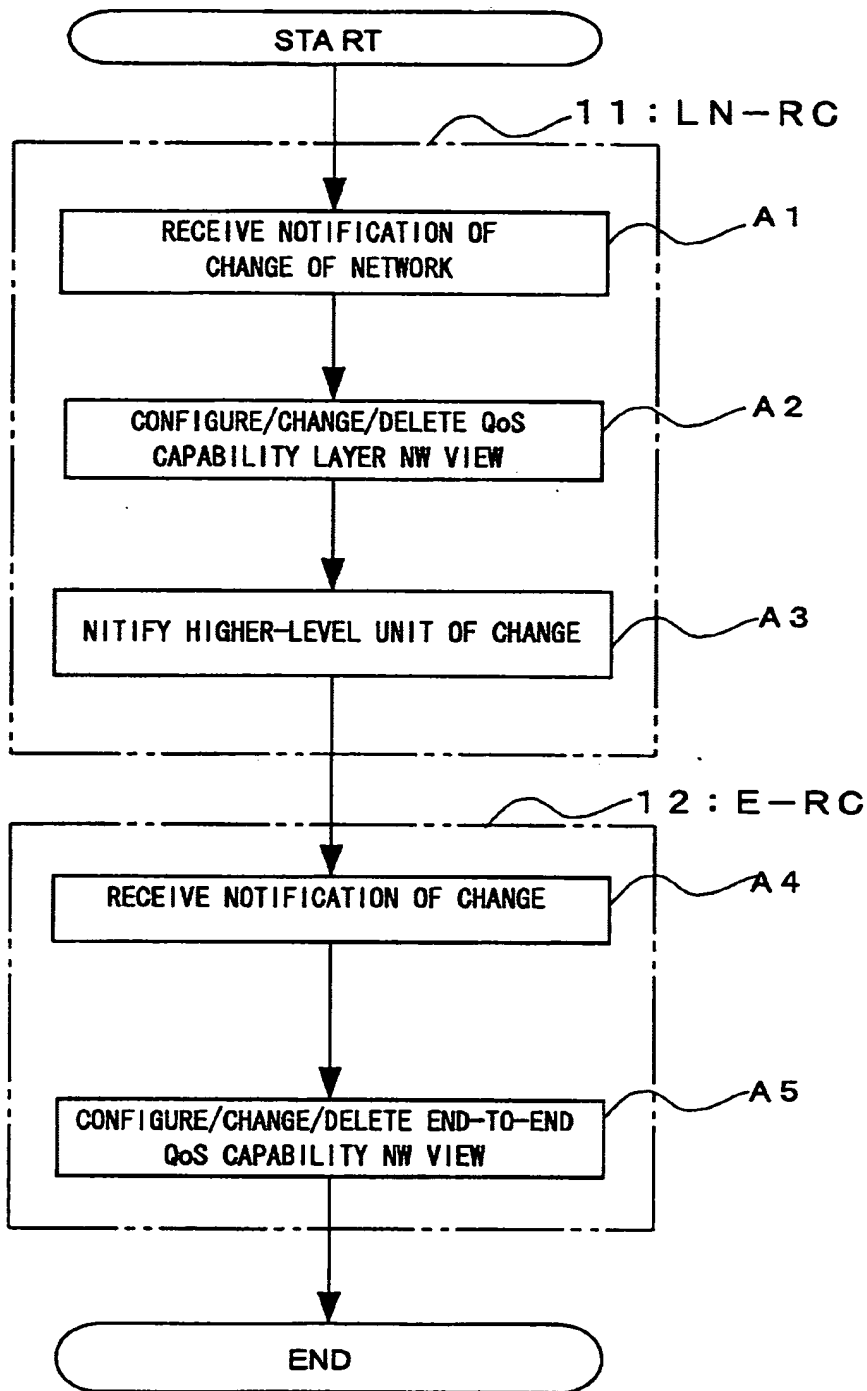
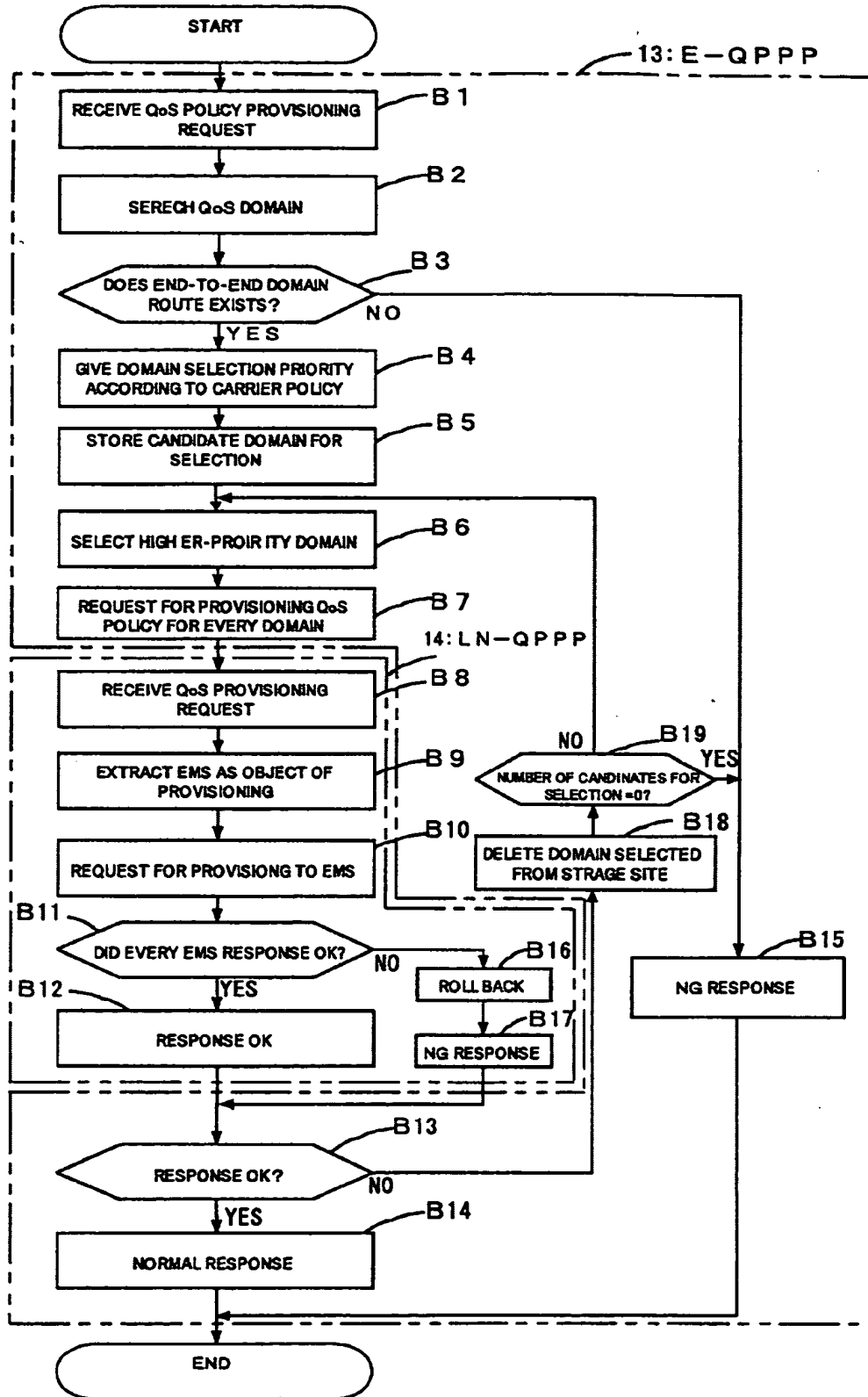

FIG. 7



005260 25402950

FIG. 8



2025 RELEASE UNDER E.O. 14176



NO. 500-25717-570

FIG. 9

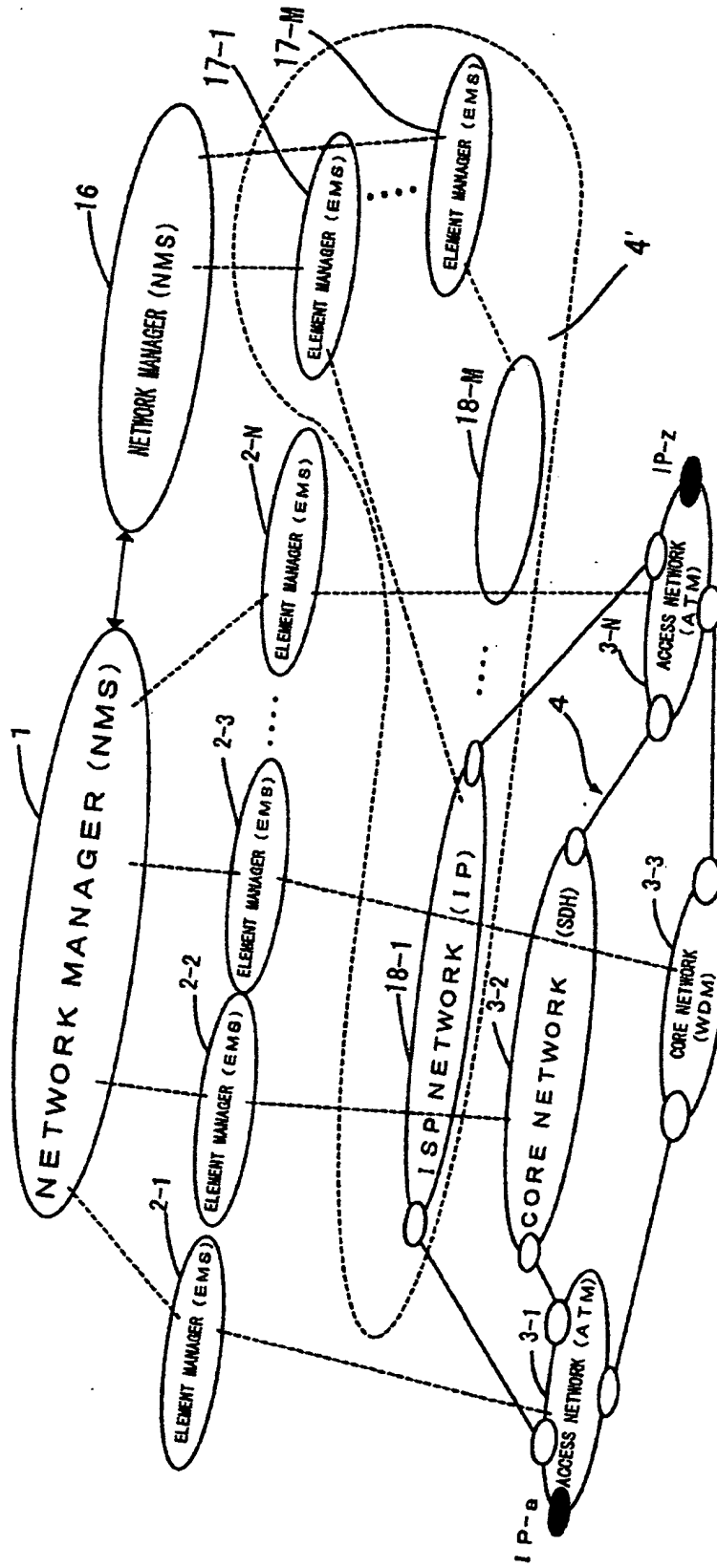

FIG. 10

